

FRANKLIN MILLS • END-TAB FILE FOLDERS

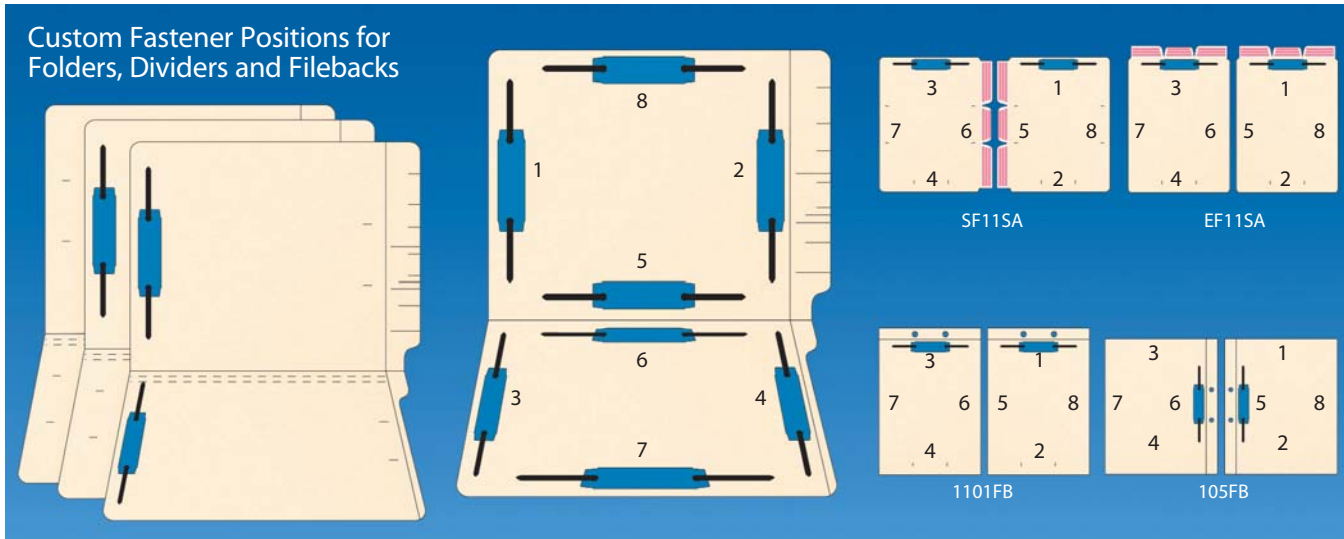

11 Point Double Ply End Tab —

9 1/2" H x 12 1/4" W (Manila)

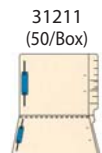
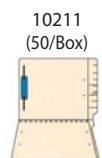
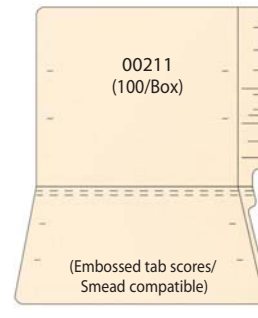
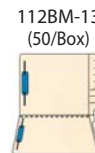
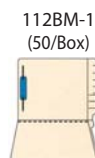
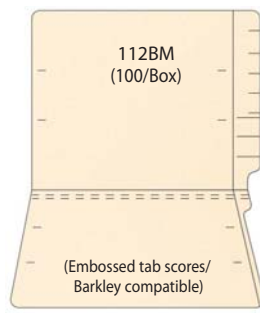
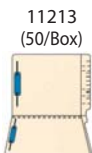
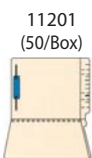
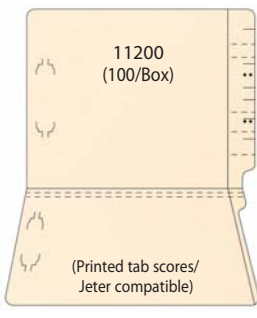

14 Point Single Ply End Tab —

9 1/2" H x 12 1/4" W (Manila)

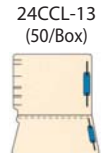
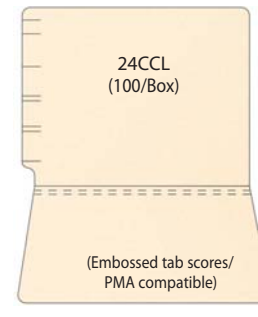
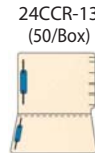
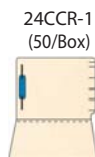
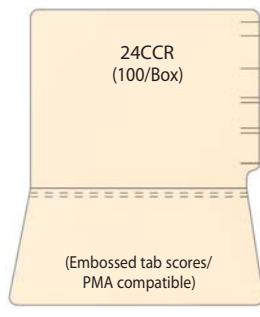
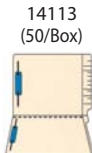
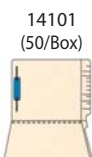
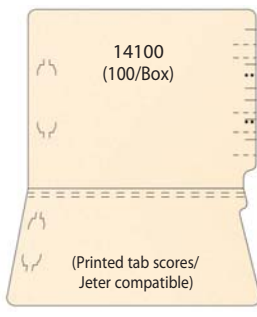

14 Point Double Ply End Tab —

9 1/2" H x 12 1/4" W (Manila)

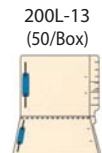
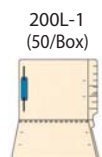
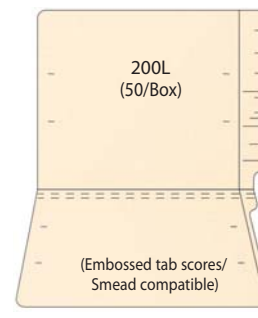
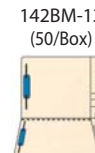
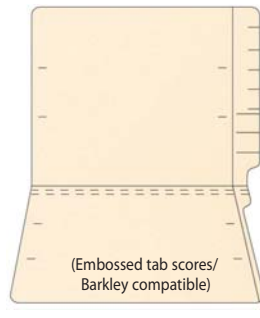
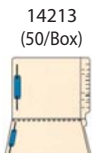
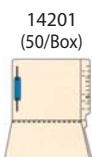
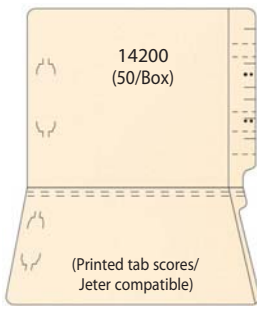

FRANKLIN MILLS END-TAB FILE FOLDERS

11 & 14 Point
Double Ply End Tab
9 1/2" H x 12 1/4" W (Colors)

Style	11 pt.	14 pt.
	11200 + color (100/Box)	00214 + color (50/Box)
	11201 + color (50/Box)	10214 + color (50/Box)
	11213 + color (50/Box)	31214 + color (50/Box)

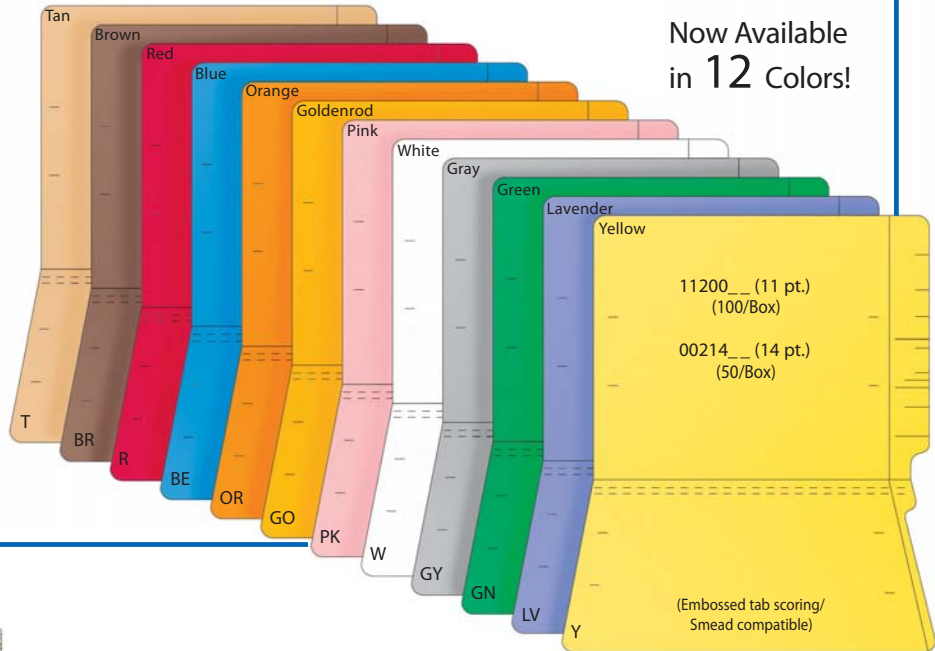

Now Available
in **12** Colors!

11200 __ (11 pt.)
(100/Box)
00214 __ (14 pt.)
(50/Box)

(Embossed tab scoring/
Smead compatible)

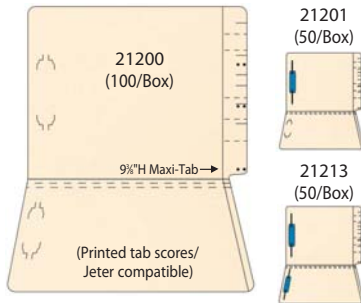

21201
(50/Box)

21213
(50/Box)

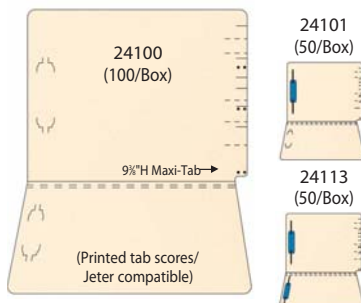

24101
(50/Box)

24113
(50/Box)

CUTLESS
Paper Cut Resistant File Folders

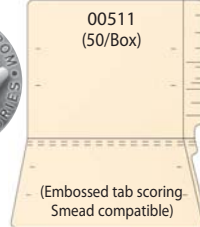

10511
(50/Box)

31511
(50/Box)

15 Point Manila
Double Ply End Tab
9 1/2" H x 12 1/4" W

Specially formulated paper provides a rounded edge during manufacturing. Softer-edge can help reduce paper cuts by up to 70% without sacrificing durability.

WaterShed
Water Resistant File Folders

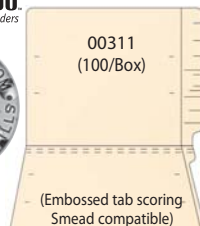

10311
(50/Box)

31311
(50/Box)

11 Point Manila
Double Ply End Tab
9 1/2" H x 12 1/4" W

Unique coating on paper resists spills and moisture. Folder wipes clean easily and can be written on with pen or pencil. Folders can also be printed to meet your specifications.

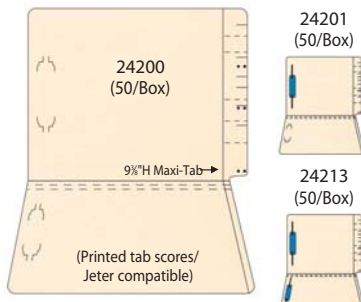

24201
(50/Box)

24213
(50/Box)

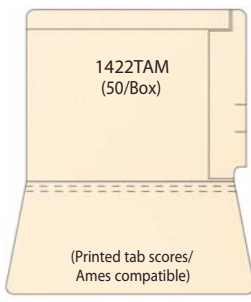

1422TAM-1
(50/Box)

1422TAM-13
(50/Box)

18 Point Single Ply (Manila)
with poly reinforced spine

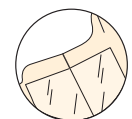
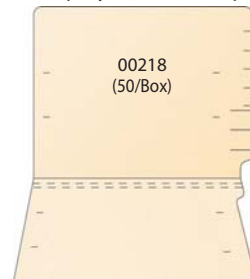

31218
(50/Box)

FRANKLIN MILLS POCKET FOLDERS

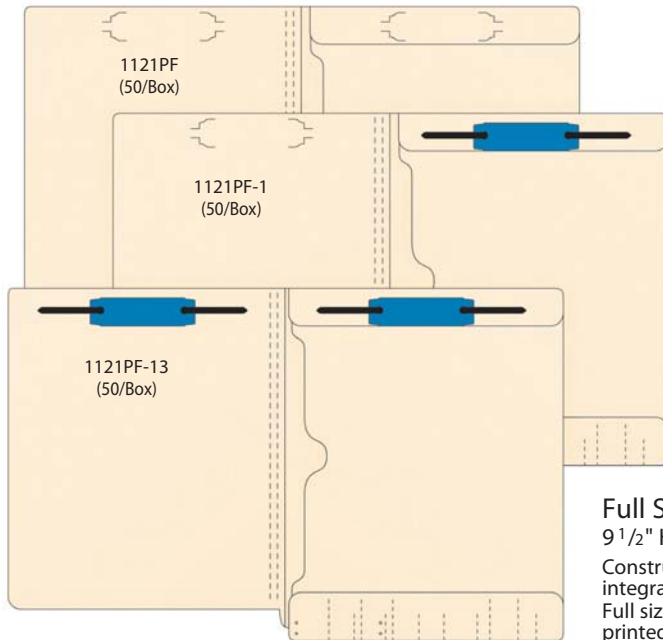

Structurally designed pocket folders or standard folders with pockets installed have become essential because of the broad assortment of documents and document sizes being stored today. Choose from our large selection of multi-functional pocket folders to meet your particular needs. If any one of these doesn't meet your needs, just ask the experts at Franklin Mills for design assistance.

Full Size Pocket Folder

9 1/2" H x 12 1/4" W
 Constructed from 11 pt. manila stock with an integral side seam pocket sealed on three sides. Full size pocket is 9 3/8" H x 12 1/4" W and has printed label placement marks.

Pre-assembled Pocket Folders 9 1/2" H x 12 1/4" W

Base folder is an 11 pt. manila #00211 with embossed label placement marks.

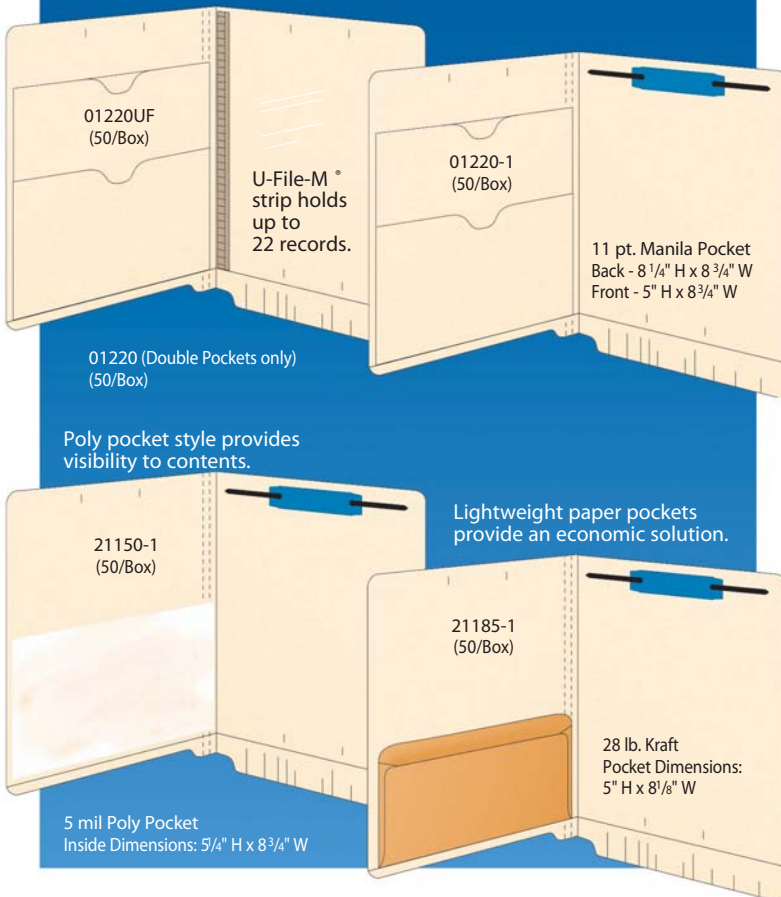

U-File-M[®] strip holds up to 22 records.

11 pt. Manila Pocket
 Back - 8 1/4" H x 8 3/4" W
 Front - 5" H x 8 3/4" W

01220 (Double Pockets only)
 (50/Box)

Poly pocket style provides visibility to contents.

Lightweight paper pockets provide an economic solution.

5 mil Poly Pocket
 Inside Dimensions: 5 1/4" H x 8 3/4" W

28 lb. Kraft
 Pocket Dimensions:
 5" H x 8 1/8" W

Full Cut-Corner Pocket Folder

9 1/2" H x 12 1/4" W; pocket 9 3/8" H x 11 5/8" W
 11 pt. manila stock, double ply tab with printed label placement marks.

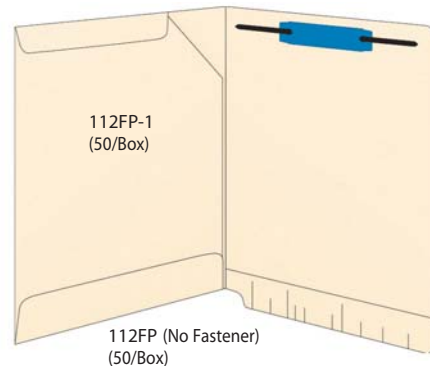

112FP (No Fastener)
 (50/Box)

Right Hand Single-Pocket Folder

9 1/2" H x 12 1/4" W; pocket 5 3/4" H x 9" W
 11 pt. manila stock, double ply tab with embossed label placement marks.

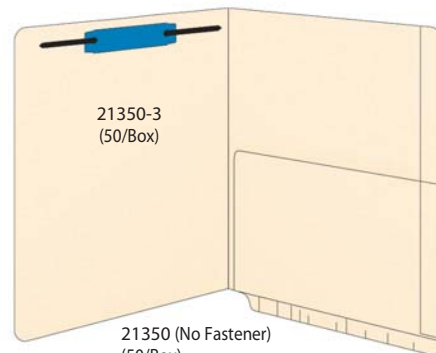

21350 (No Fastener)
 (50/Box)

FRANKLIN MILLS POCKET FOLDERS

Left Hand Single-Pocket Folder
 11 & 14 pt. Manila and Colors
 9 1/2" H x 12 1/4" W; pocket 5 3/4" D
 front panel 9" H
 Embossed label placement marks

	Pt.	Plain	Fastener
Manila	11	11350	11351
	14	13350	13351
Colors	11	12350 + color	12351 + color
	14	14350 + color	14351 + color

All folders packed 50/Box.
 Specify color when ordering.

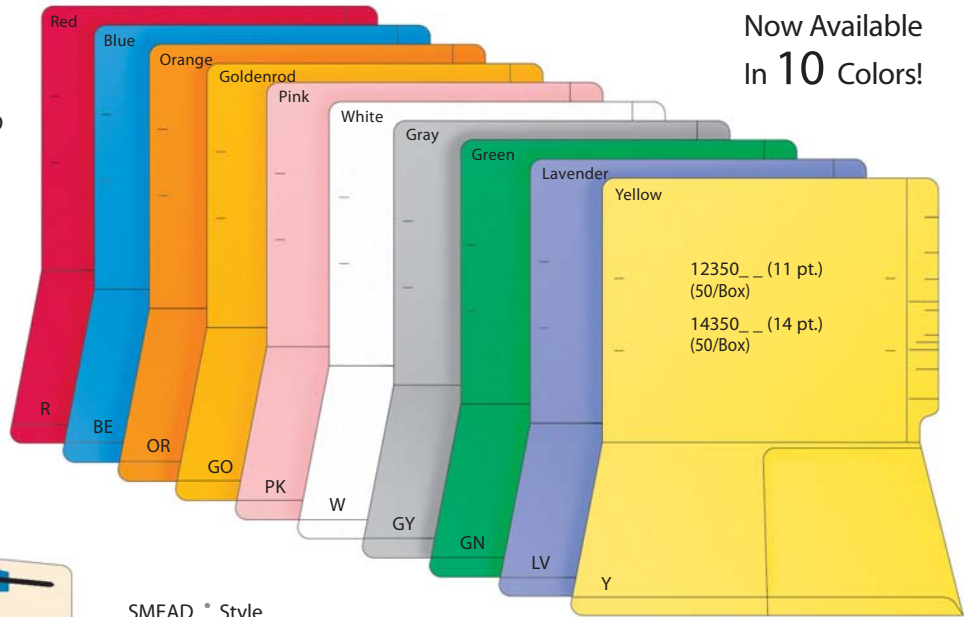

Now Available
 In **10** Colors!

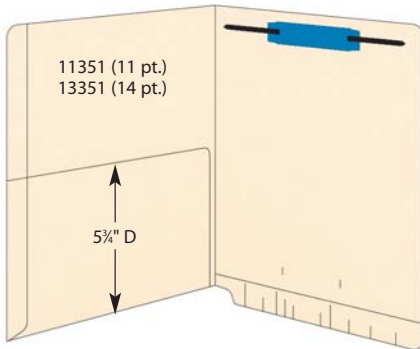

SMEAD[®] Style
 also available



Pocket Folders with Strength & Capacity

Full Size Pocket Folder — 9 1/2" H x 12 1/4" W
 Constructed from a 14 pt. (#24100) folder with an 11 pt. (#011FP) pocket laminated to the inside provides maximum durability. Dimensions of pocket are 9 3/8" H x 12 1/4" W.

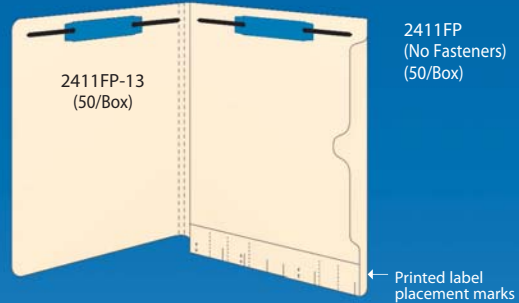

Twin Pocket Folder — 9 1/2" H x 12 1/4" W
 Constructed from 11 pt. manila stock, folder has two pockets for storage of panorex x-rays, photos, etc.

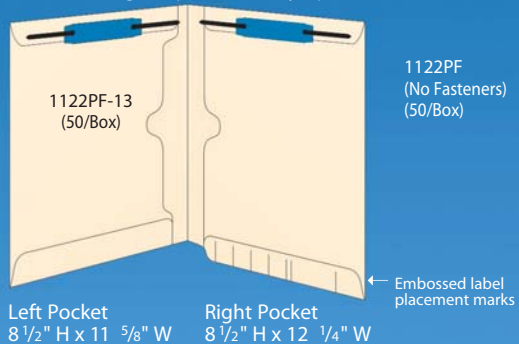

Double Outside-Pocket Folders

9 1/2" H x 12 1/4" W
 11 pt. manila construction;
 Folder design is perfect for dental practices to hold panorex x-rays, photos, etc.

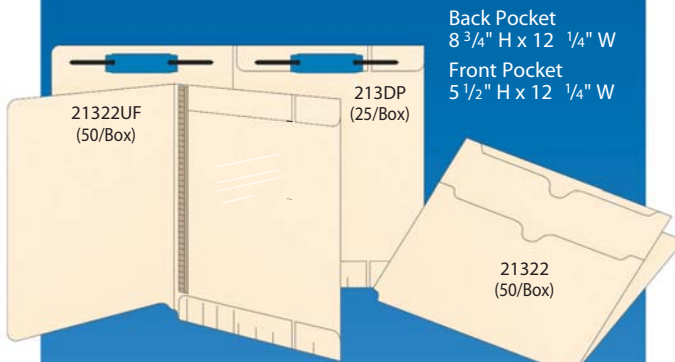

21322	Double pocket folder with no additional fasteners installed
21322UF	Includes a U-File-M [®] strip in position #5; holds up to 22 records
213DP	2" Bonded fasteners in positions 1 & 3 for maximum storage capacity

FRANKLIN MILLS

CLASSIFICATION FOLDERS AND DIVIDERS

Classification folders allow the contents of each chart to be easily categorized and sub-divided.

Valu-Classifile Folders

9 1/2" H x 12 1/4" W

EC200L – Preassembled from stock components, folder features a 14 pt. reinforced folder (#200L-13) with an 11 pt. divider (#SF11SA-2). Four compartments, each with one 2" bonded fastener, provides up to 1/4" storage capacity in each compartment.

33350 – Base single pocket folder (#13351) is 14 pt. thick with an 11 pt. divider (#SF11SA-2) installed in position #5.

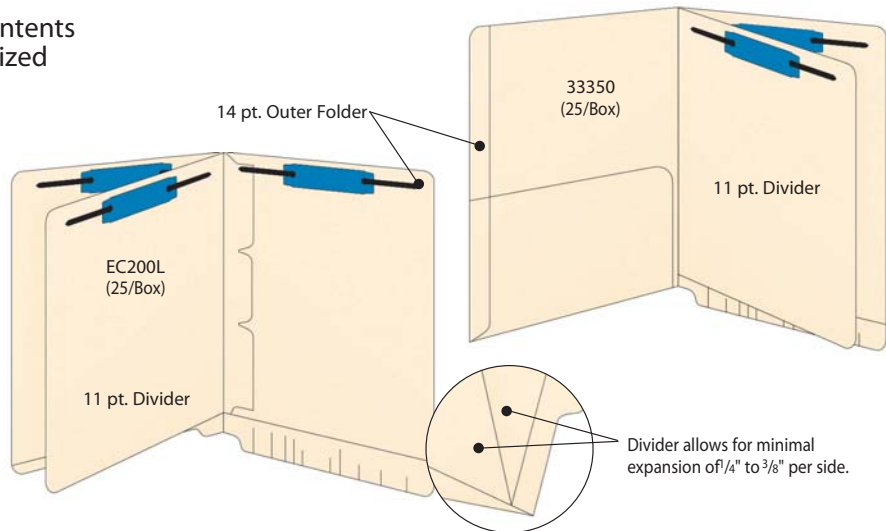

Dura-Classifile Folders

9 1/2" H x 12 1/4" W

Tyvek[®] spine provides a flexible gusset and long life for active records.

- EXC2D3** – 2 dividers; 6 compartments
- EXC1D2** – 1 divider; 4 compartments
- EXF134** – No dividers; 2 compartments

Construction features 18 pt. single ply folder with 1 3/4" expansion in all styles. Because of the flexible Tyvek gusset, these folders will not bulk-up on the shelf and take up valuable space.

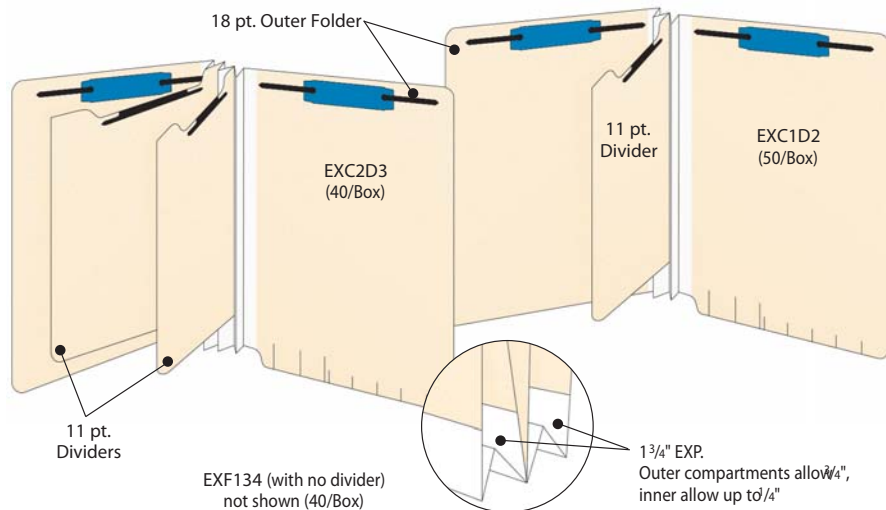

Super-Classifile Folders

9 1/2" H x 12 1/4" W

Poly reinforced gusset for durability and large compartments for max-storage.

- EC2D3** – 2 dividers, 6 compartments, 3" expansion
- EC1D2** – 1 divider, 4 compartments, 2" expansion

Construction features 14 pt. outer folder with laminated 32 pt. thick dividers. Extra heavy dividers provide the necessary rigidity to hold maximum volume of documents. Folders will not sag or bow on the shelf.

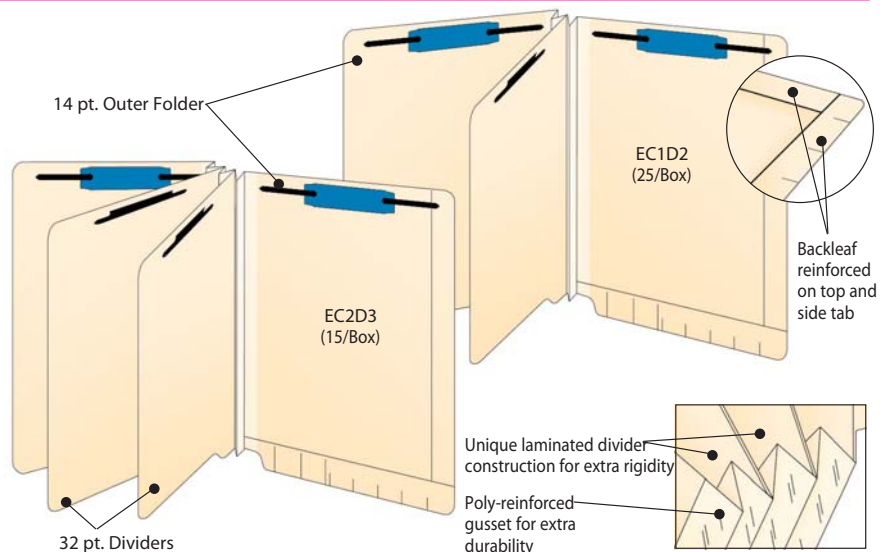

FRANKLIN MILLS DIVIDERS AND FILEBACKS

Dental-Classfile Folder

9 1/2" H x 12 1/4" W

Outside full pocket for x-ray storage

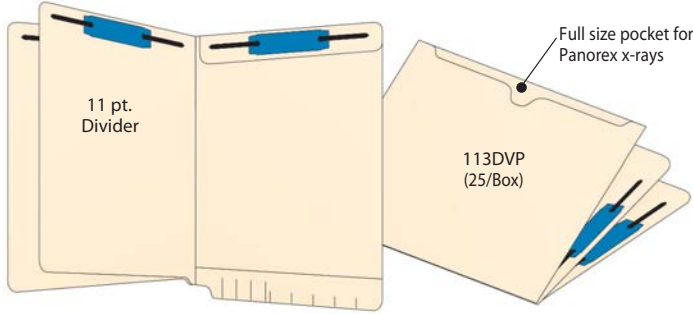

113DVP – Unique construction and features, this 11 pt. folder has full outside pocket that is 12 1/4" W x 8 1/4" D and will accommodate Panorex x-rays without having to trim them. Embossed label placement lines.

Utility Classfile Folder

9 1/2" H x 12 1/4" W x 2" Expansion

Multiple features provide flexibility

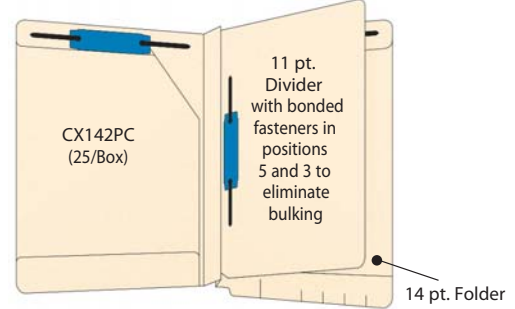

CX142PC – Features 14 pt. construction with 11 pt. divider, this folder with a full pocket and 2" expansion provides flexible storage alternatives.

Self-Adhesive Dividers and Filebacks Help Organize

Divide the contents of your folders to better organize documents. Easy to install. Use more than one style together in a folder. All dividers are made from 11 pt. manila stock and have a 7/8" flap with self-adhesive tape. Die-cuts on flaps allow positioning around fasteners.

Folders sold separately

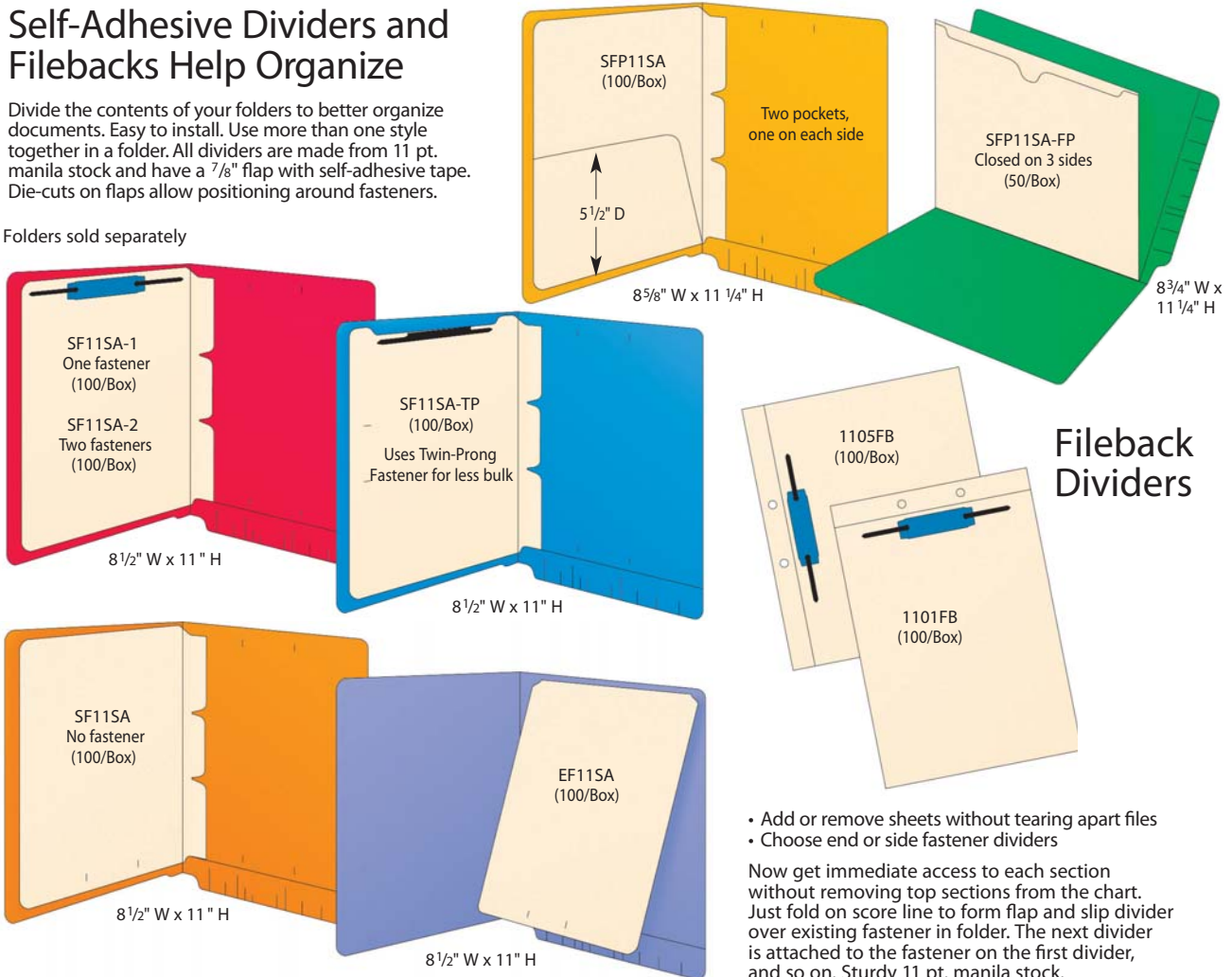

- Add or remove sheets without tearing apart files
- Choose end or side fastener dividers

Now get immediate access to each section without removing top sections from the chart. Just fold on score line to form flap and slip divider over existing fastener in folder. The next divider is attached to the fastener on the first divider, and so on. Sturdy 11 pt. manila stock.

FRANKLIN MILLS FILE POCKETS AND ENVELOPES

End-Tab File Pockets

9 1/2" H x 12 1/4" W –
11 pt. Manila and Colors

Diagonal cut front panel allows easy access to contents. Closed on two sides to secure documents from falling out. Embossed label placement marks on a double ply end-tab.

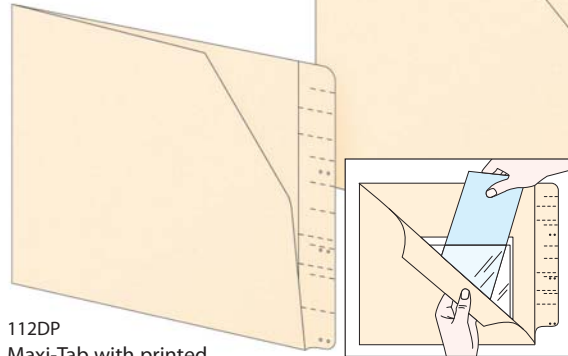

112DP
Maxi-Tab with printed label marks

M112DP-50 (40/Box)
11 pt. manila pocket with inside poly pocket

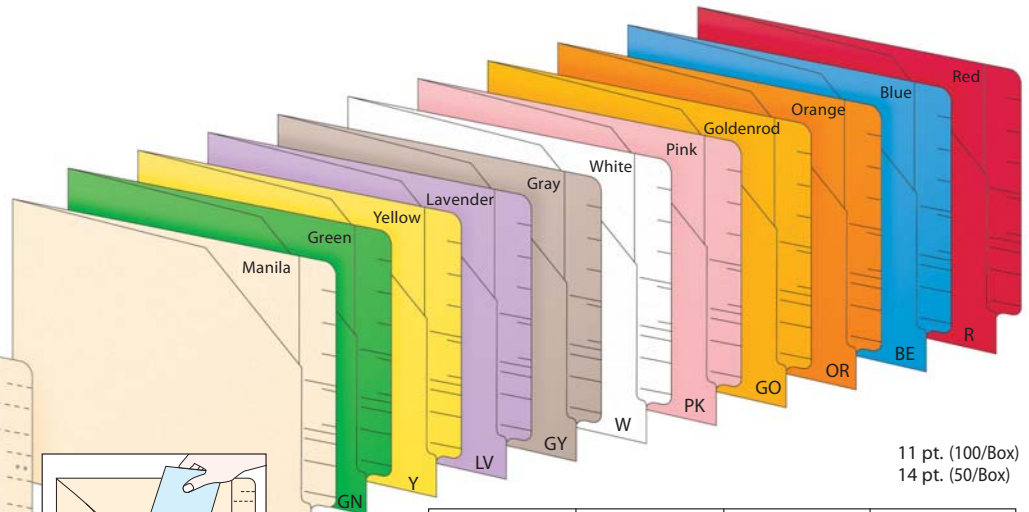

11 pt. (100/Box)
14 pt. (50/Box)

M112DP 11 pt. Manila	M112DPY 11 pt. Yellow	M112DPW 11 pt. White	M112DOR 11 pt. Orange
M142DP 14 pt. Manila	M112DPLY 11 pt. Lavender	M112DPPK 11 pt. Pink	M112DPBE 11 pt. Blue
M112DPGN 11 pt. Green	M112DPGY 11 pt. Gray	M112DPGO 11 pt. Goldenrod	M112DPR 11 pt. Red

Now Available
in Manila
and 5 Colors!

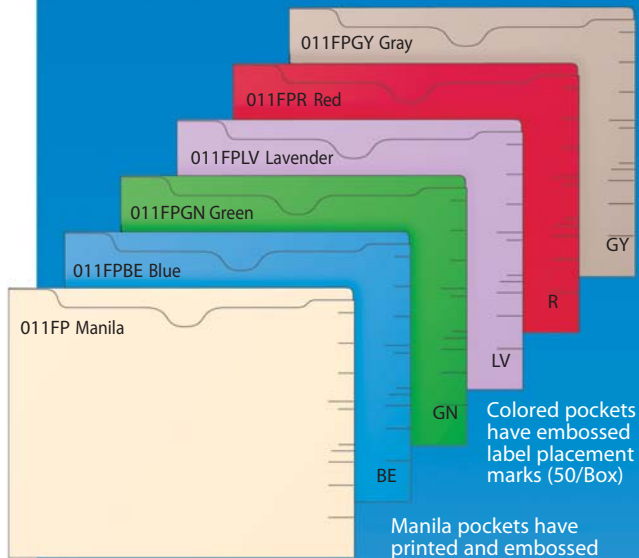

Colored pockets have embossed label placement marks (50/Box)

Manila pockets have printed and embossed label placement lines (100/Box)

End-Tab File Pockets

9 1/2" H x 12 1/4" W
11 pt. Manila and Colors

Reinforced side seam construction with single ply top. Pockets are closed on three sides for maximum security and document protection.

11 Point End-Tab Pockets

9 1/2" H x 12 1/4" W – Printed Color Border (100/Box)

More economical than colored stock, these manila pockets with printed borders have a double ply top and side for extra durability. Pockets have embossed tab scores for easy label placement.

